

Crossing Minimization in Storyline Visualizations

M. Gronemann, M. Jünger, F. Liers, **F. Mambelli**

GD 2016, Athens, 21.09.2016



Storyline Visualization



Linus van Pelt



Snoopy



Lucy van Pelt

Storyline Visualization



Storyline Visualization



Snoopy

Linus

Lucy

Storyline Visualization



Snoopy

Linus

Lucy

Storyline Visualization



Snoopy

Linus

Lucy

Storyline Visualization

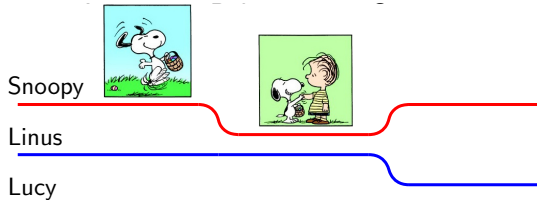

Storyline Visualization



Snoopy

Linus

Lucy



Storyline Visualization

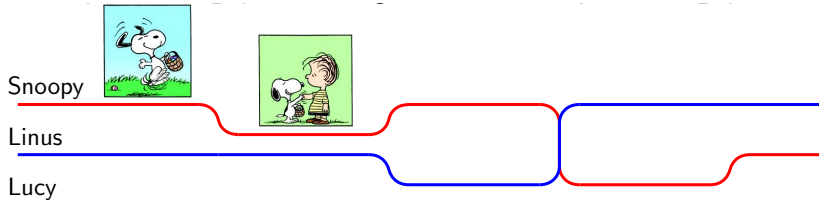

Storyline Visualization



Snoopy

Linus

Lucy

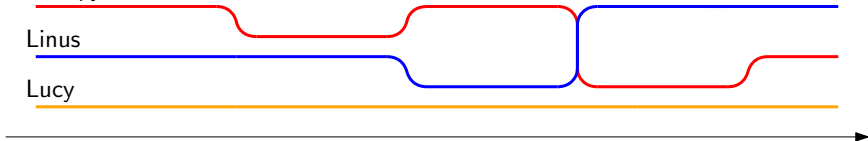

Storyline Visualization



Snoopy

Linus

Lucy

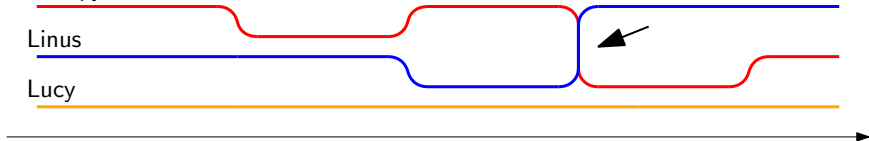

Storyline Visualization



Snoopy

Linus

Lucy

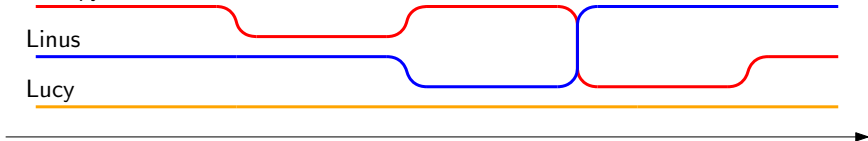

Storyline Visualization

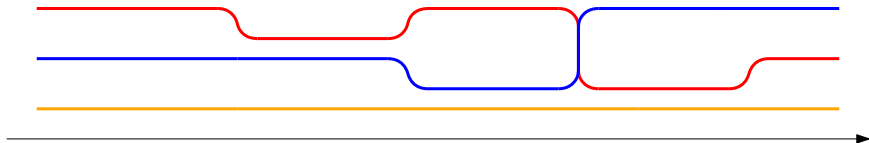

Storyline Visualization

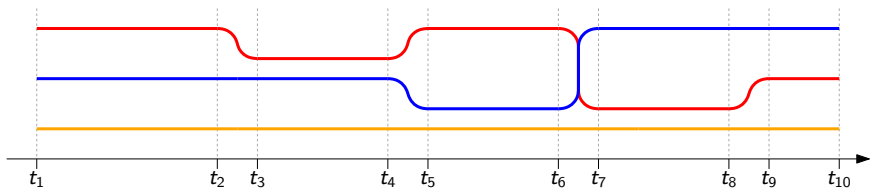

Storyline Visualization

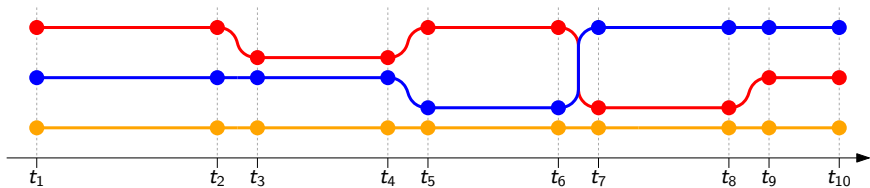

Storyline Visualization

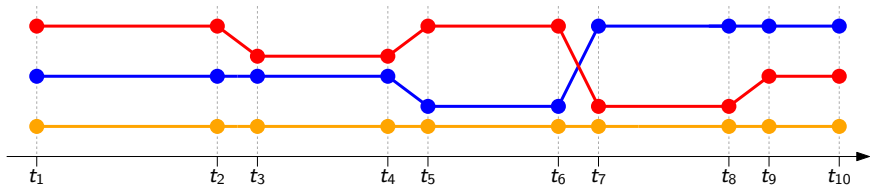

Storyline Visualization

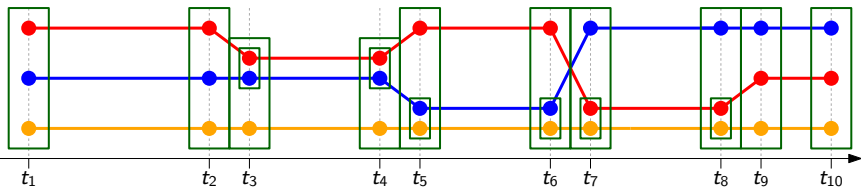

MLCM problem

Jünger, Lee, Mutzel, Odenthal, 1997.

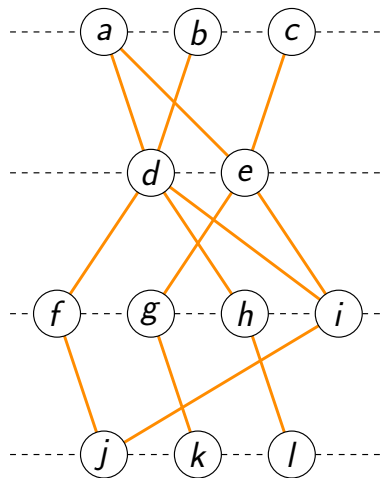

MLCM problem

Jünger, Lee, Mutzel, Odenthal, 1997.

Target: minimize crossings sorting nodes on layers.

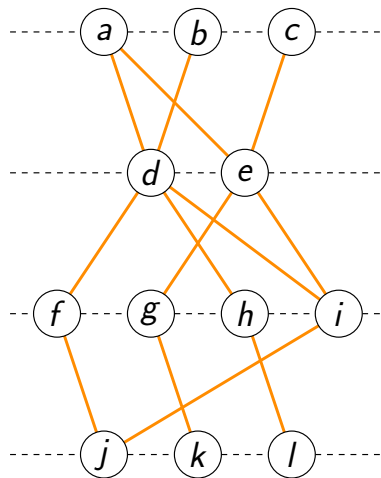

MLCM problem

Jünger, Lee, Mutzel, Odenthal, 1997.

Target: minimize crossings sorting nodes on layers.

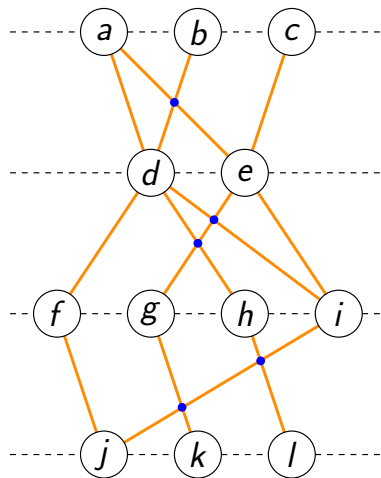

MLCM problem

Jünger, Lee, Mutzel, Odenthal, 1997.

Target: minimize crossings sorting nodes on layers.

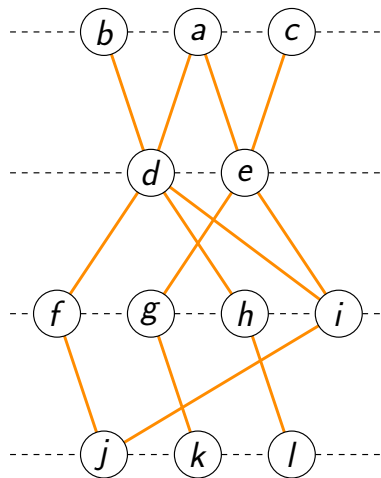

MLCM problem

Jünger, Lee, Mutzel, Odenthal, 1997.

Target: minimize crossings sorting nodes on layers.

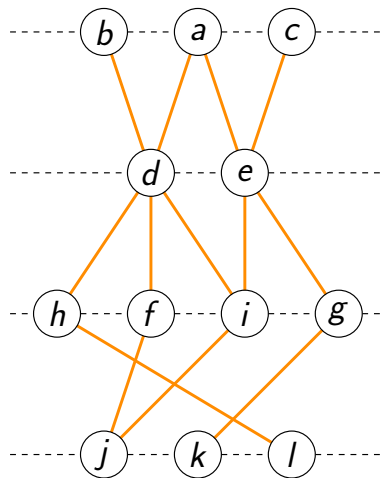

MLCM problem

Jünger, Lee, Mutzel, Odenthal, 1997.

Target: minimize crossings sorting nodes on layers.

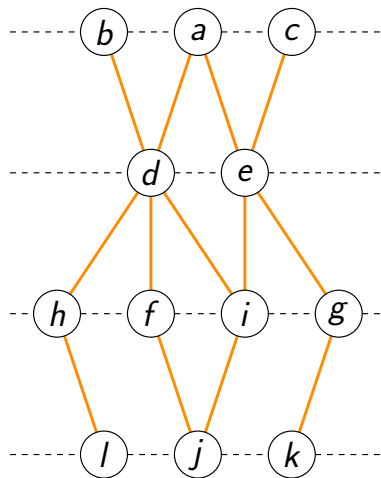

MLCM & Max-Cut

Healy, Kuusik, 1999.

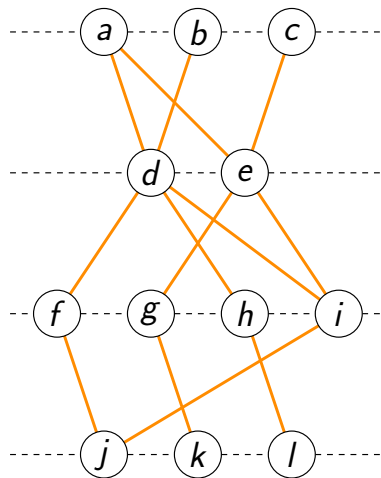

MLCM & Max-Cut

Healy, Kuusik, 1999.

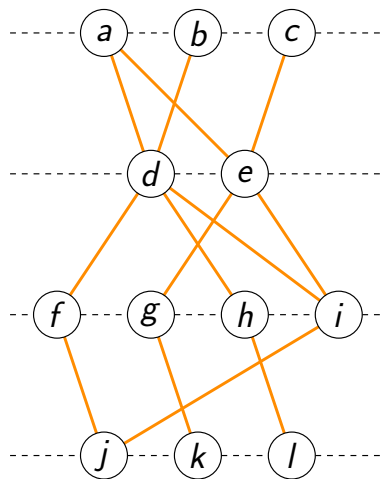

MLCM & Max-Cut

Healy, Kuusik, 1999.

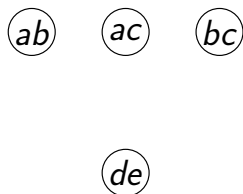
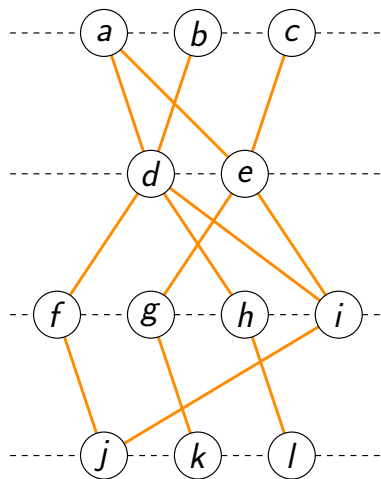

MLCM & Max-Cut

Healy, Kuusik, 1999.

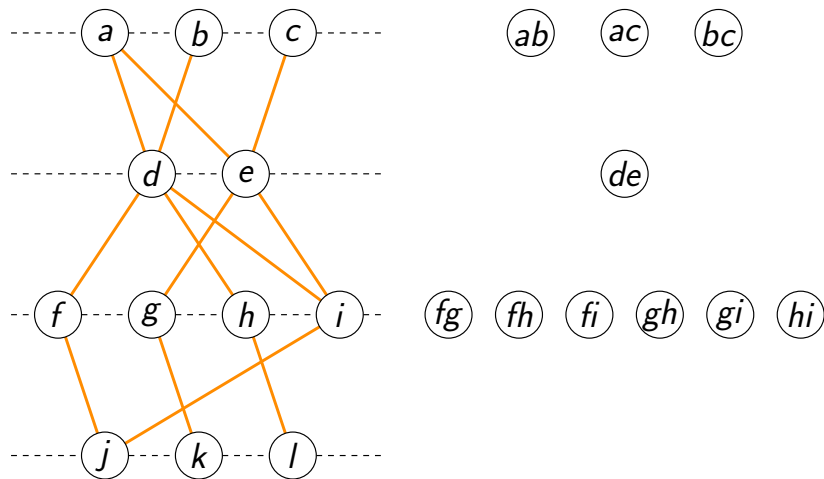

MLCM & Max-Cut

Healy, Kuusik, 1999.

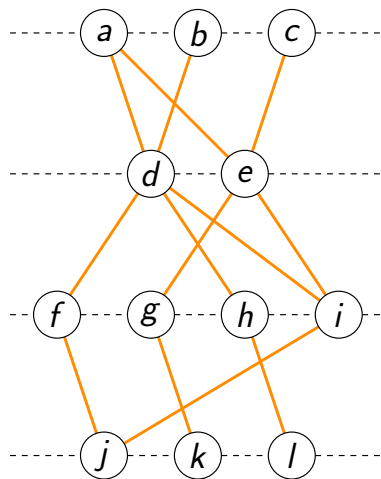

(ab) (ac) (bc)

(de)

(fg) (fh) (fi) (gh) (gi) (hi)

(jk) (jl) (kl)

MLCM & Max-Cut

Healy, Kuusik, 1999.

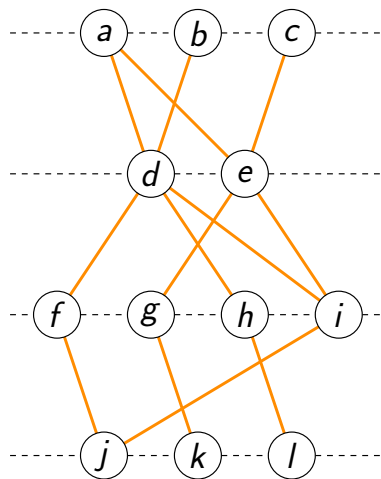

ab *ac* *bc*

de

fg *gi* *fi* *gh* *fh* *hi*

jk *kl* *jl*

MLCM & Max-Cut

Healy, Kuusik, 1999.

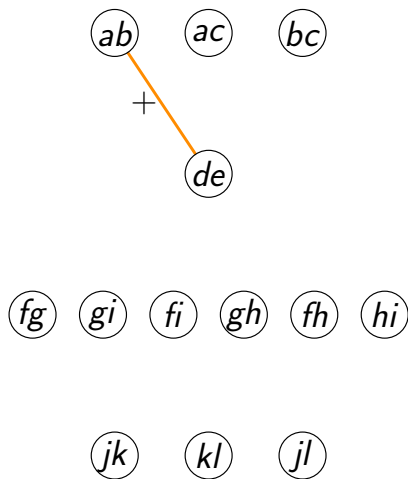
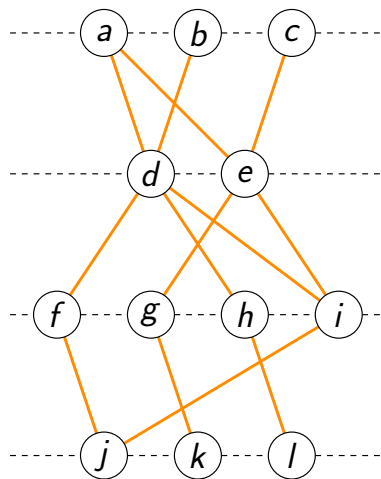

MLCM & Max-Cut

Healy, Kuusik, 1999.

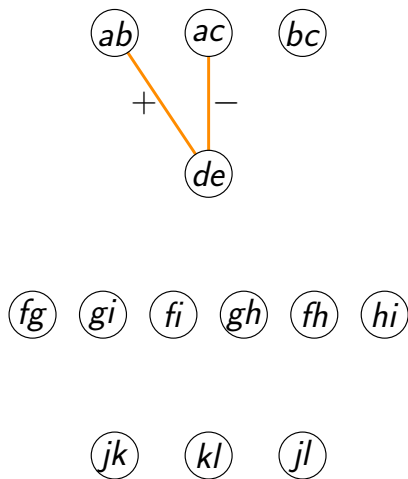
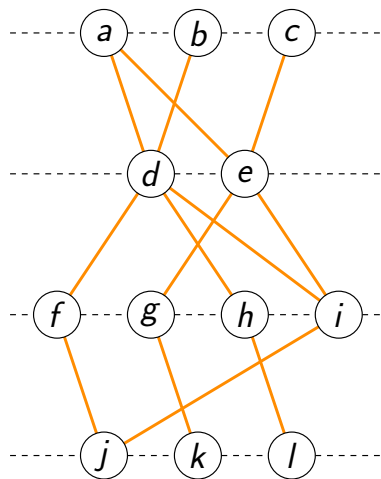

MLCM & Max-Cut

Healy, Kuusik, 1999.

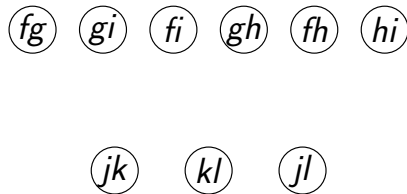
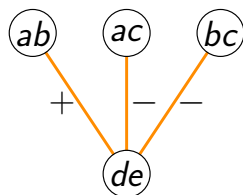
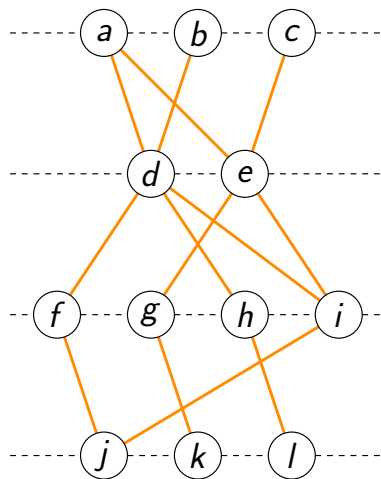

MLCM & Max-Cut

Healy, Kuusik, 1999.

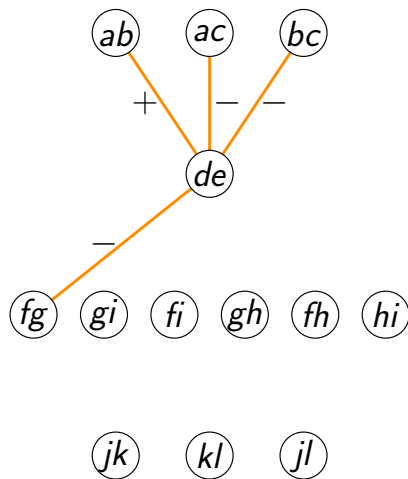
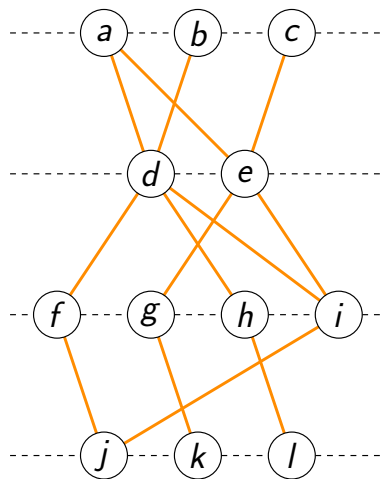

MLCM & Max-Cut

Healy, Kuusik, 1999.

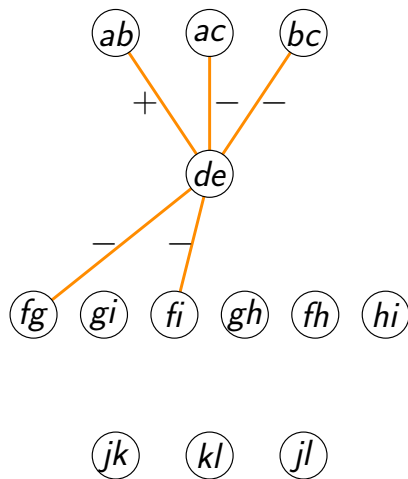
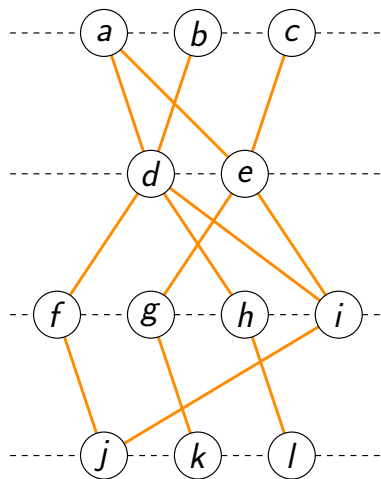

MLCM & Max-Cut

Healy, Kuusik, 1999.

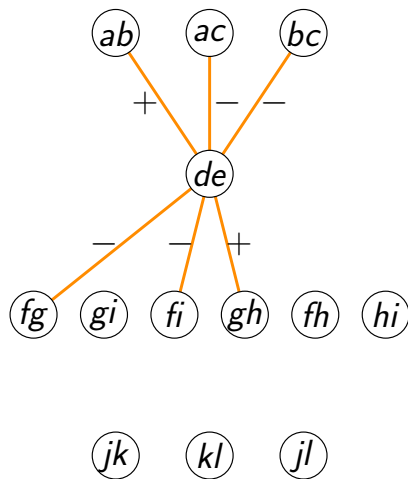
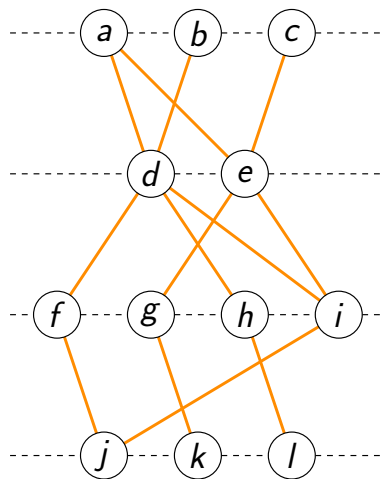

MLCM & Max-Cut

Healy, Kuusik, 1999.

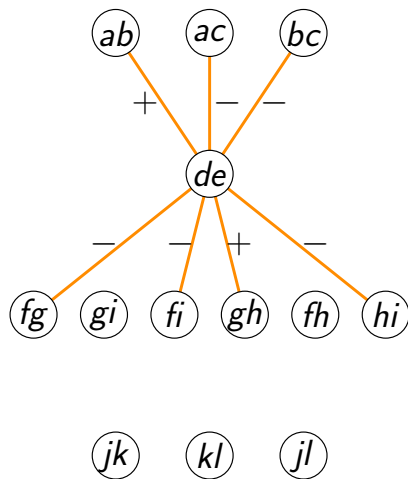
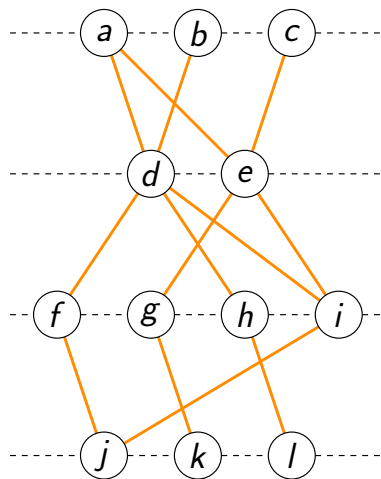

MLCM & Max-Cut

Healy, Kuusik, 1999.

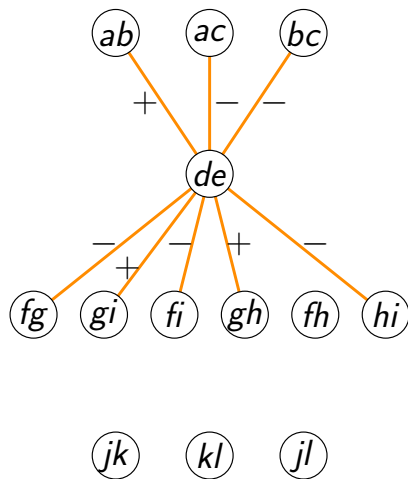
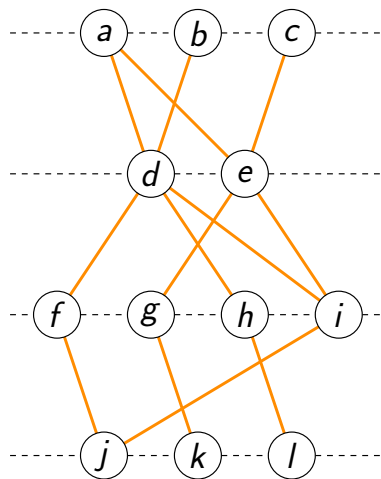

MLCM & Max-Cut

Healy, Kuusik, 1999.

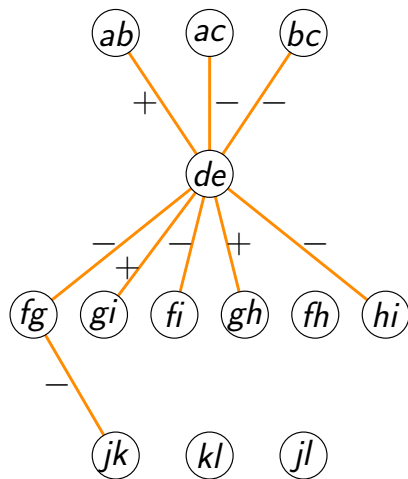
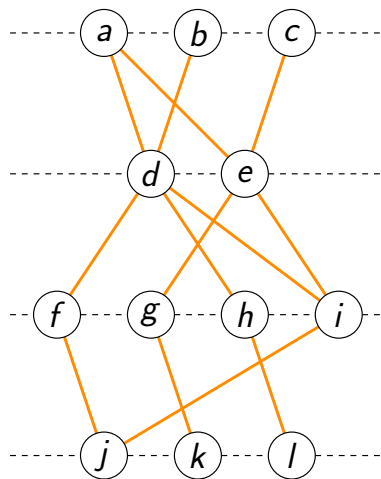

MLCM & Max-Cut

Healy, Kuusik, 1999.

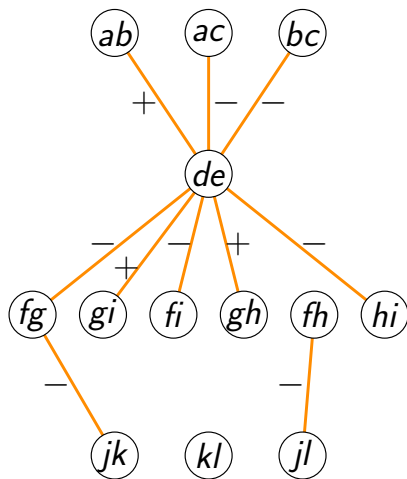
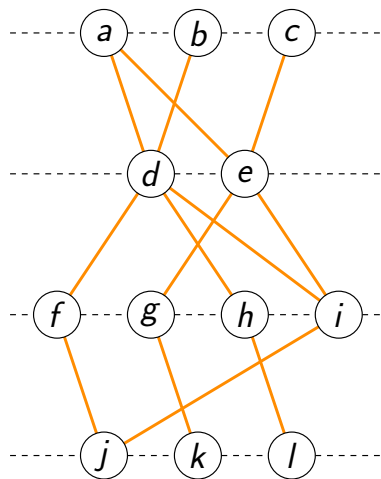

MLCM & Max-Cut

Healy, Kuusik, 1999.

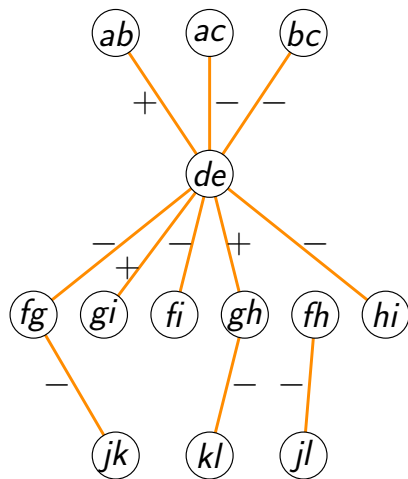
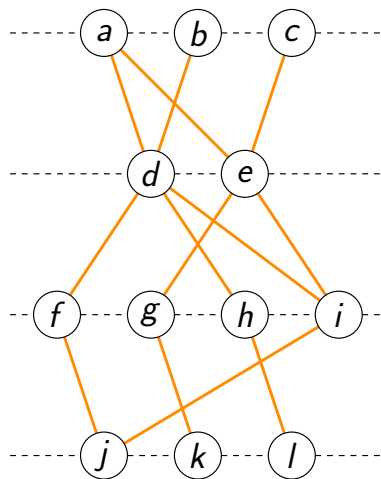

MLCM & Max-Cut

Healy, Kuusik, 1999.

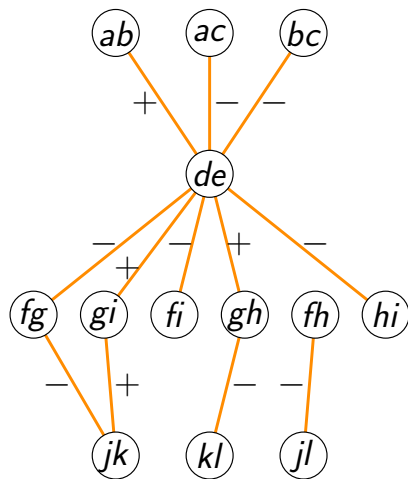
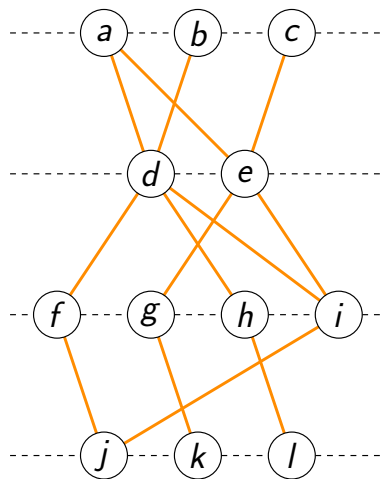

MLCM & Max-Cut

Healy, Kuusik, 1999.

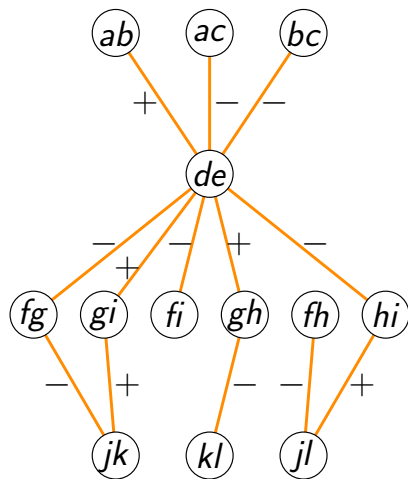
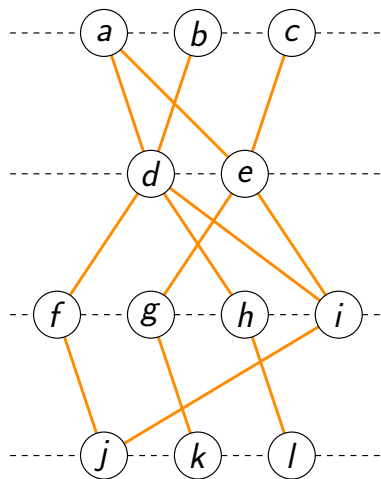

MLCM & Max-Cut

Healy, Kuusik, 1999.

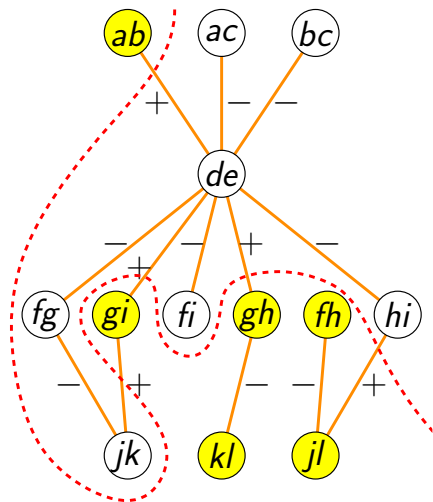
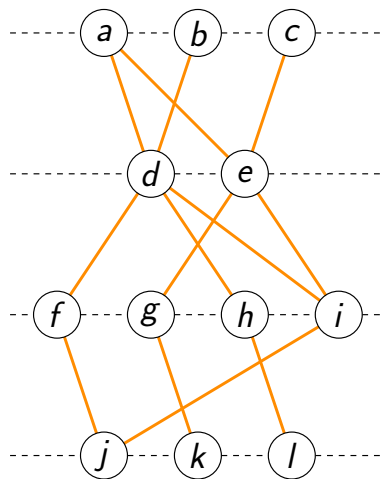

MLCM & Max-Cut

Healy, Kuusik, 1999.

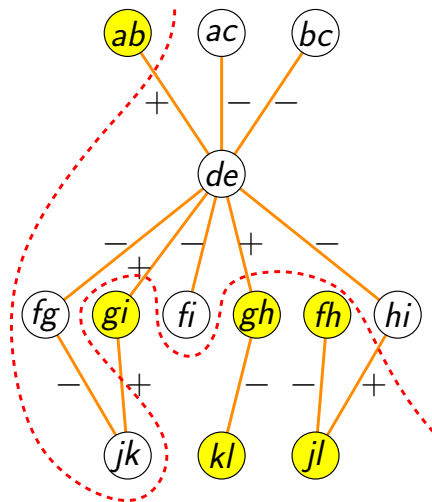
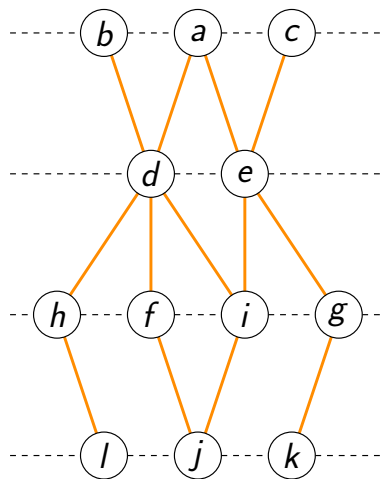

MLCM & Max-Cut

Healy, Kuusik, 1999.

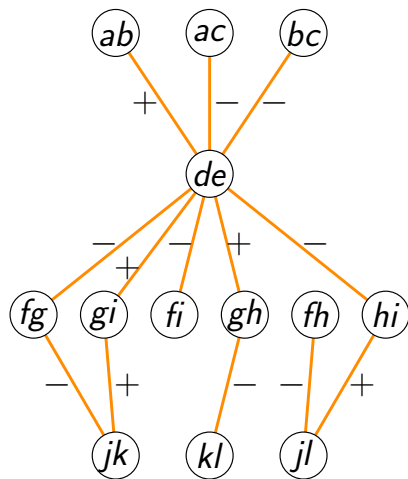
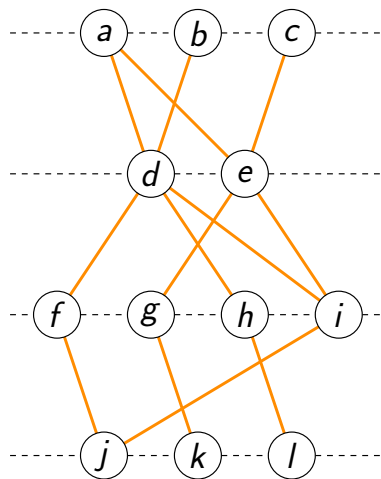

MLCM & Max-Cut

Healy, Kuusik, 1999.

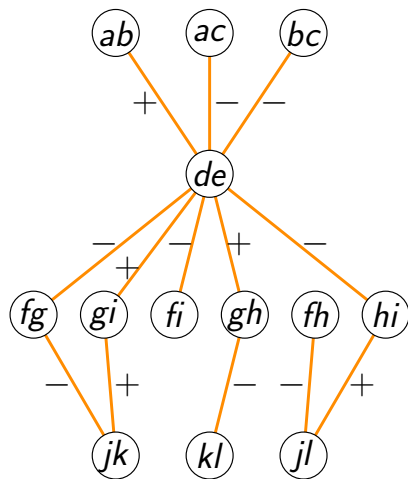
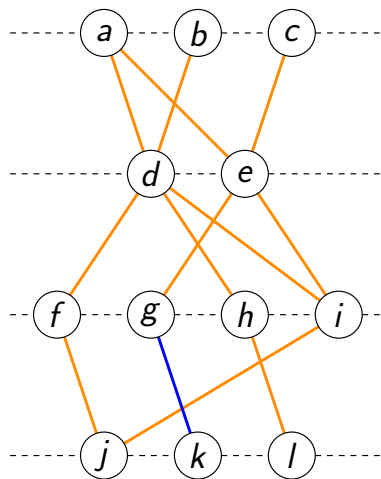

MLCM & Max-Cut

Healy, Kuusik, 1999.

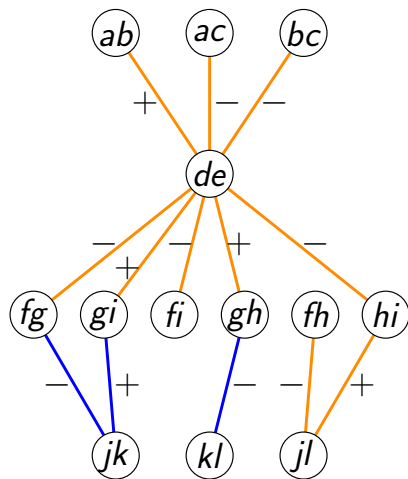
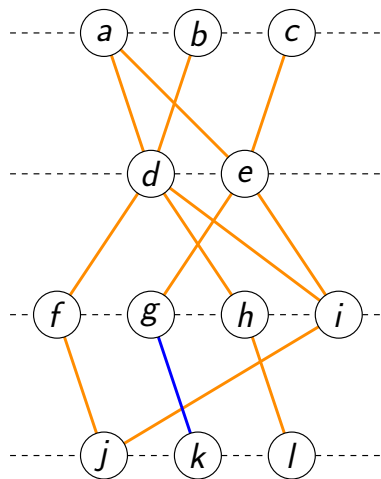

MLCM & Max-Cut

Healy, Kuusik, 1999.

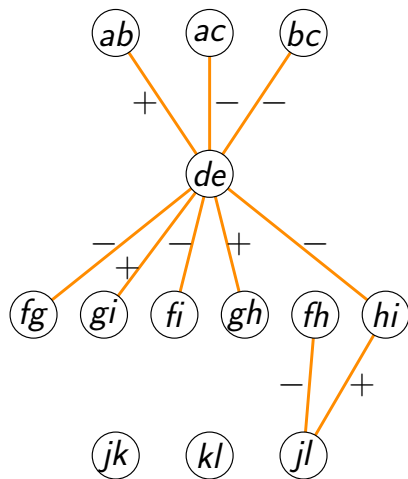
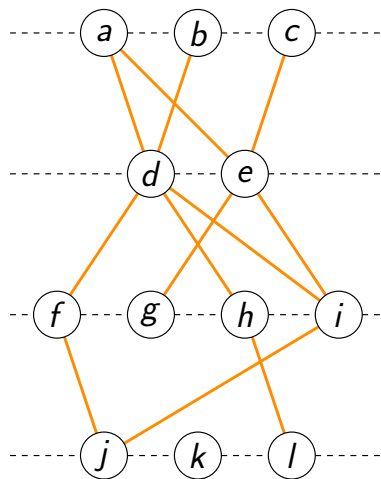

MLCM & Max-Cut

Healy, Kuusik, 1999.

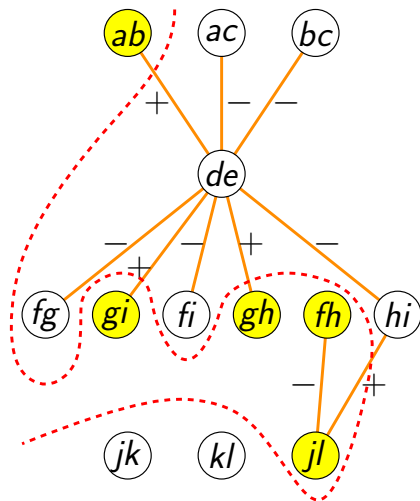
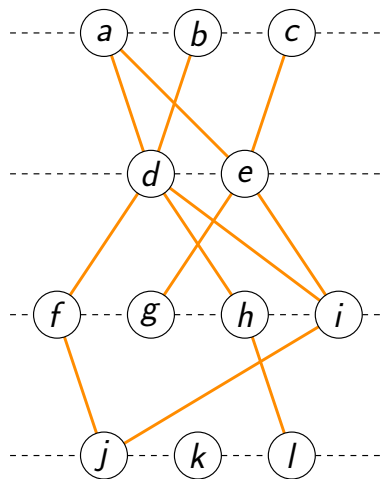

MLCM & Max-Cut

Healy, Kuusik, 1999.

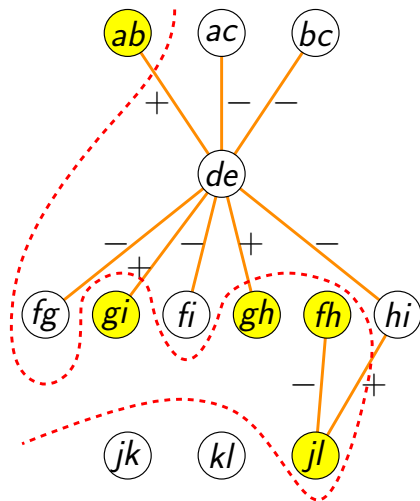
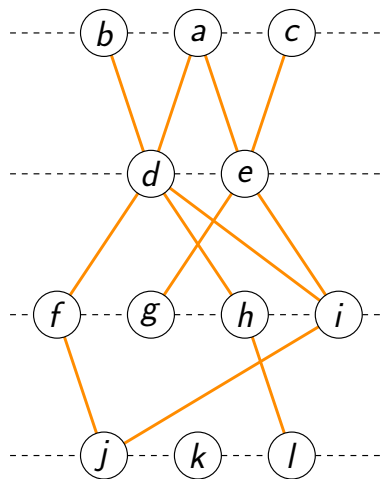

MLCM & Max-Cut

Healy, Kuusik, 1999.

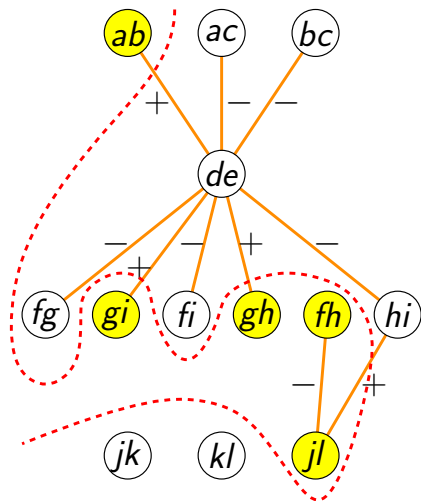
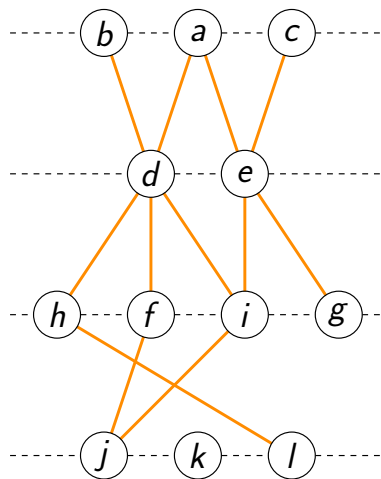

MLCM & Max-Cut

Healy, Kuusik, 1999.

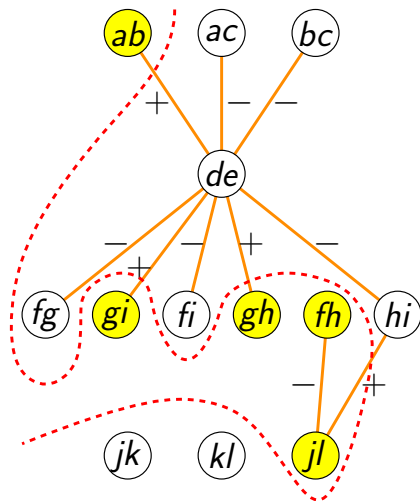
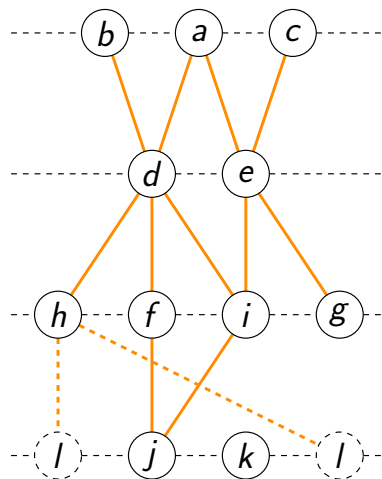

MLCM & Max-Cut

Healy, Kuusik, 1999.

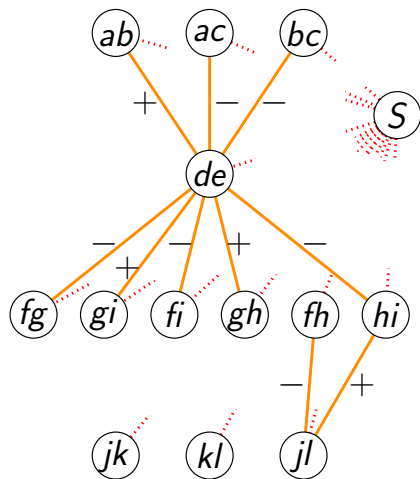
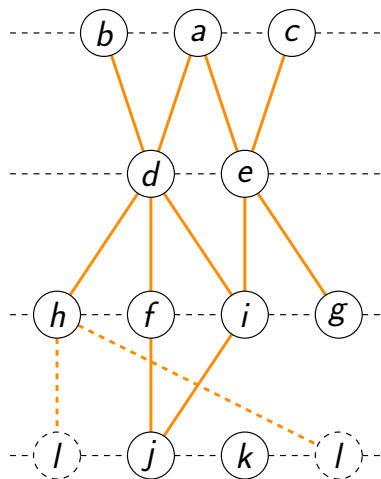

Trees on layers

Baumann, Buchheim, Liers, 2010.

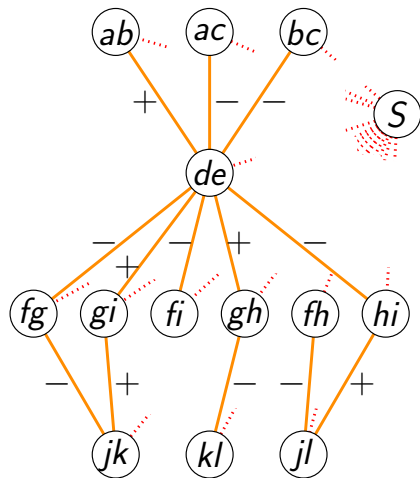
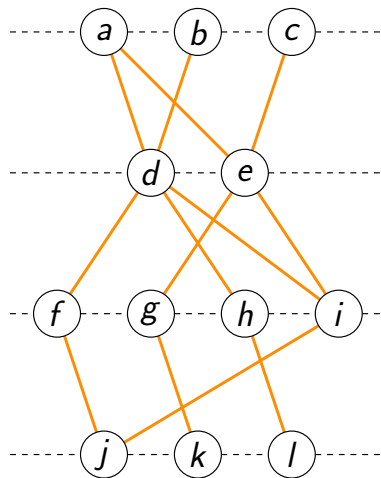

Trees on layers

Baumann, Buchheim, Liers, 2010.

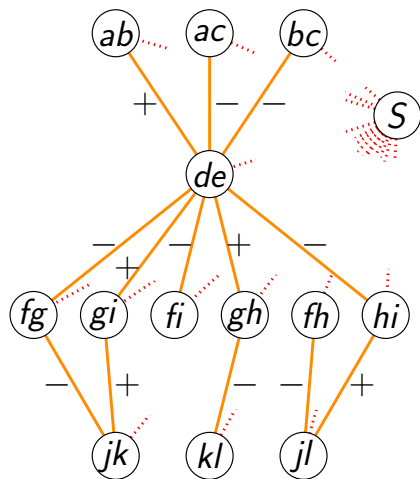
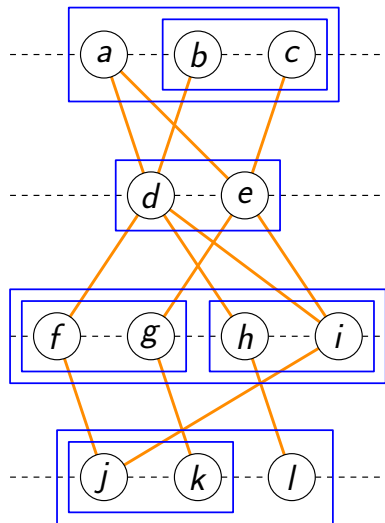

Trees on layers

Baumann, Buchheim, Liers, 2010.

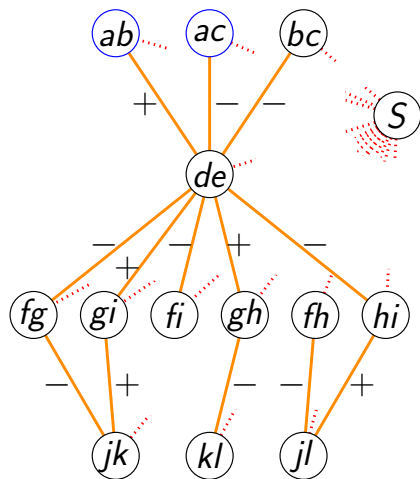
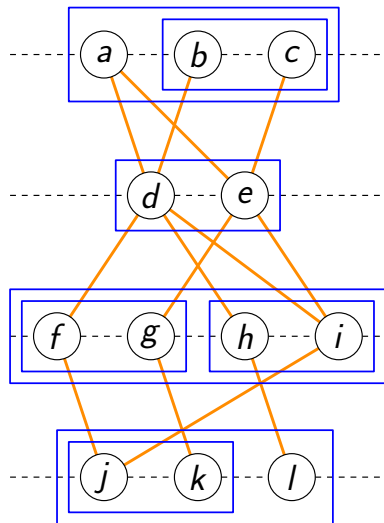

Trees on layers

Baumann, Buchheim, Liers, 2010.

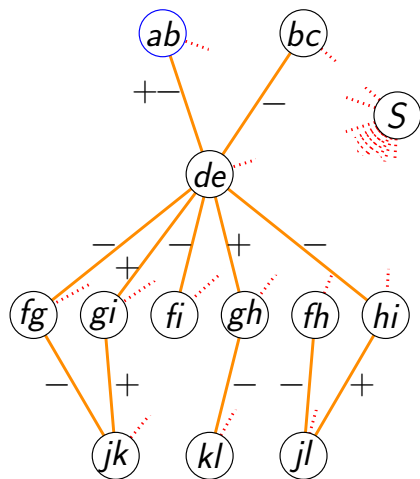
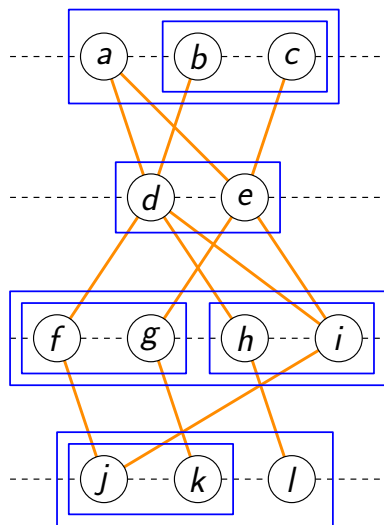

Trees on layers

Baumann, Buchheim, Liers, 2010.

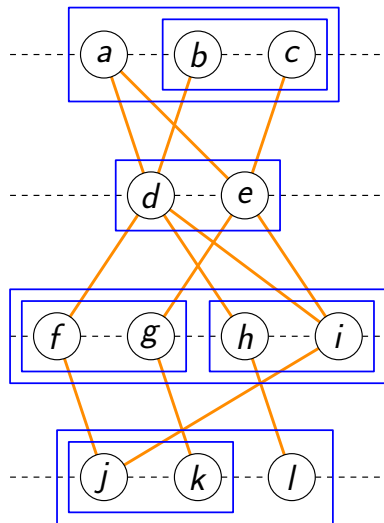

cr
x

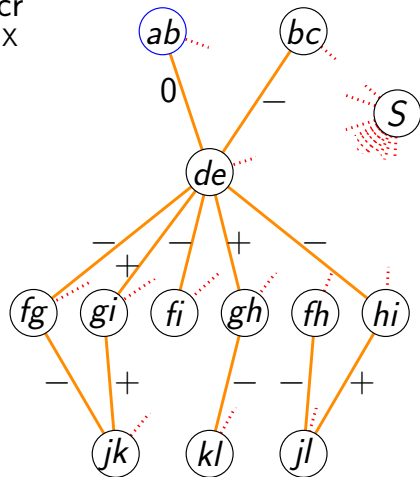

Trees on layers

Baumann, Buchheim, Liers, 2010.

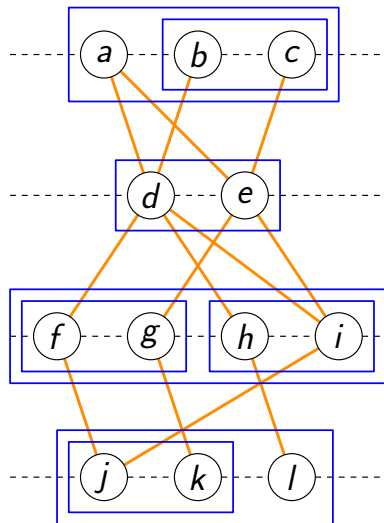

cr
x

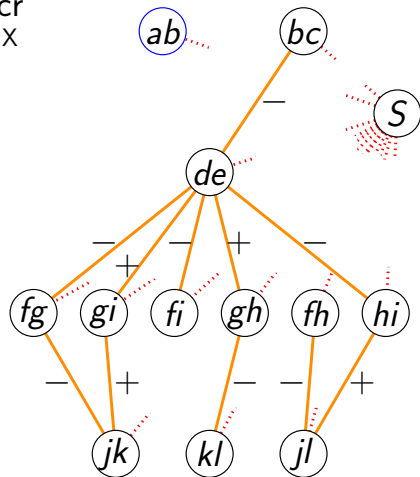

Trees on layers

Baumann, Buchheim, Liers, 2010.

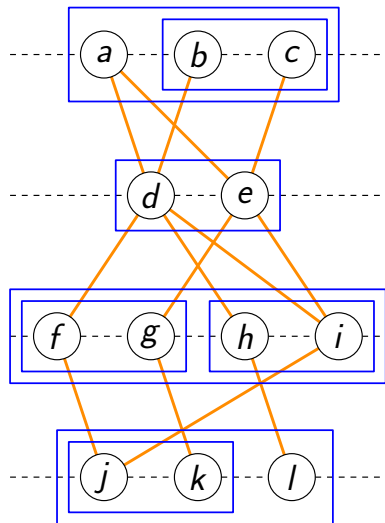

cr
x

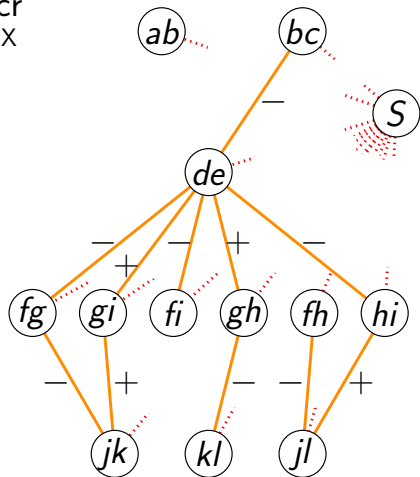

Trees on layers

Baumann, Buchheim, Liers, 2010.

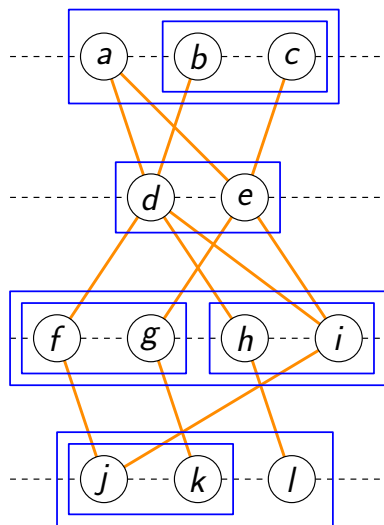

cr
x

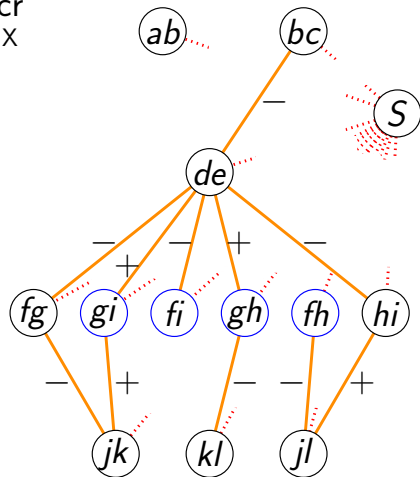

Trees on layers

Baumann, Buchheim, Liers, 2010.

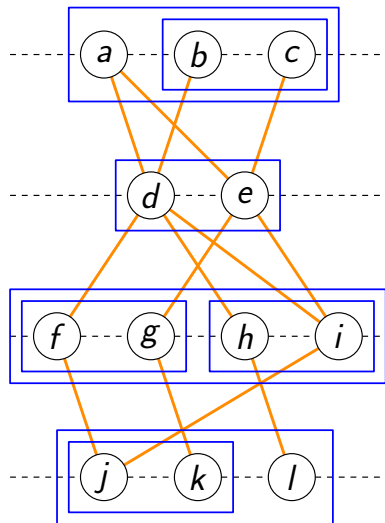

cr
x

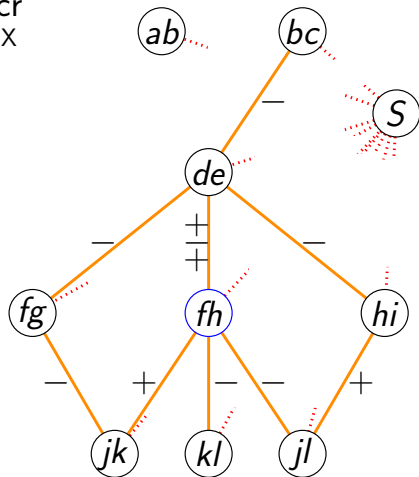

Trees on layers

Baumann, Buchheim, Liers, 2010.

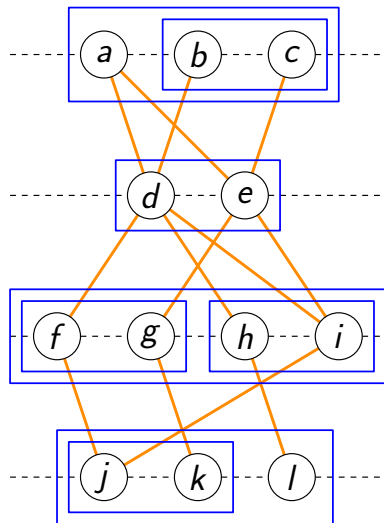

cr
x
x

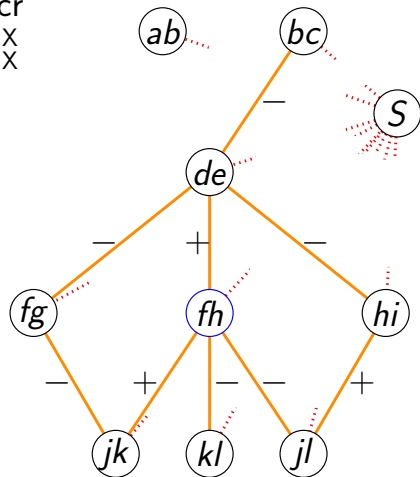

Trees on layers

Baumann, Buchheim, Liers, 2010.

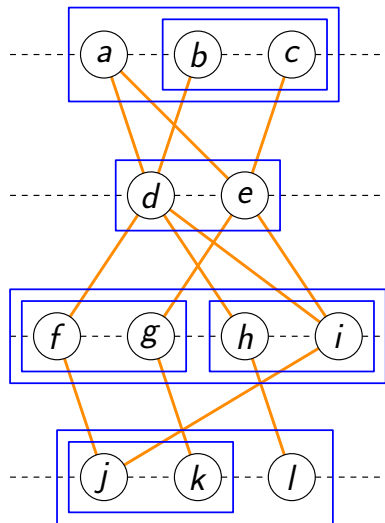

cr
x
x

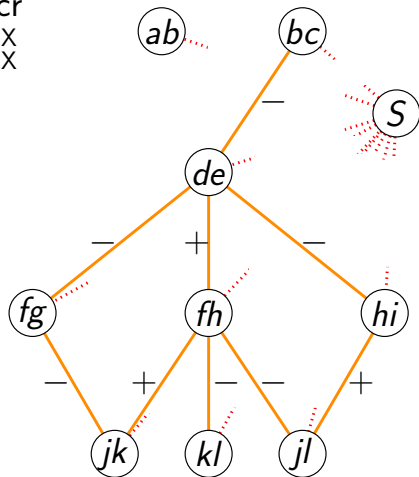

Trees on layers

Baumann, Buchheim, Liers, 2010.

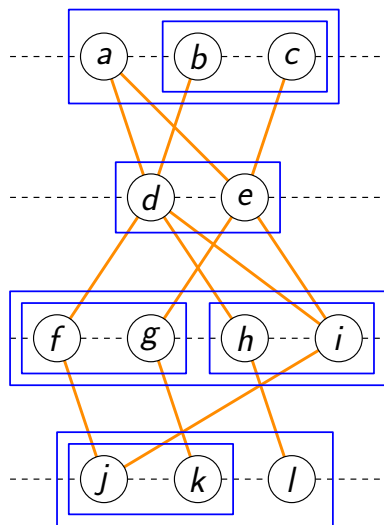

cr
x
x

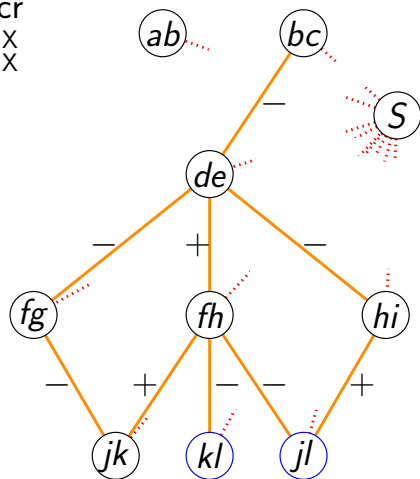

Trees on layers

Baumann, Buchheim, Liers, 2010.

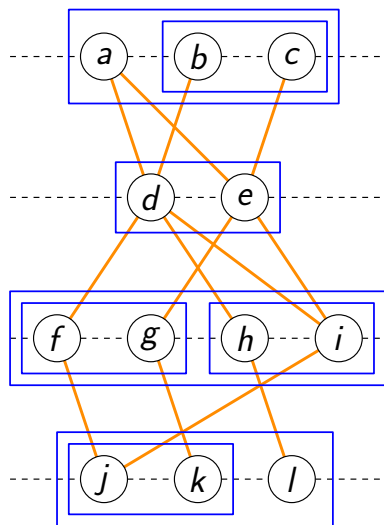

cr
x
x

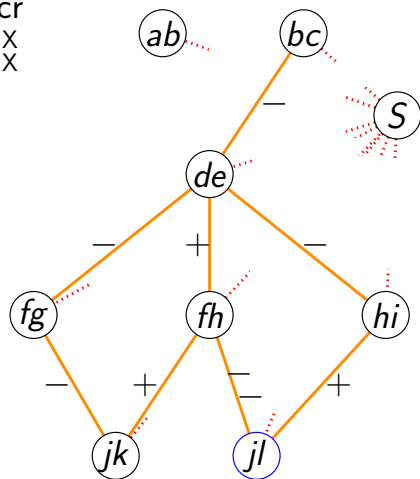

Trees on layers

Baumann, Buchheim, Liers, 2010.

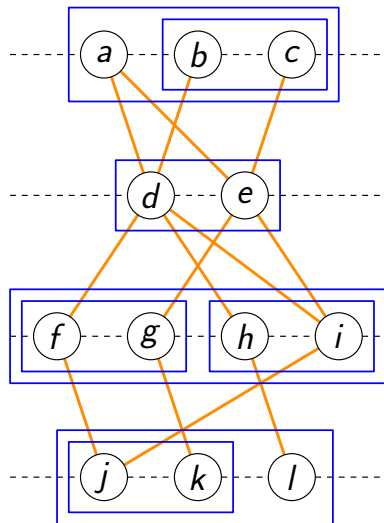

cr
x
x

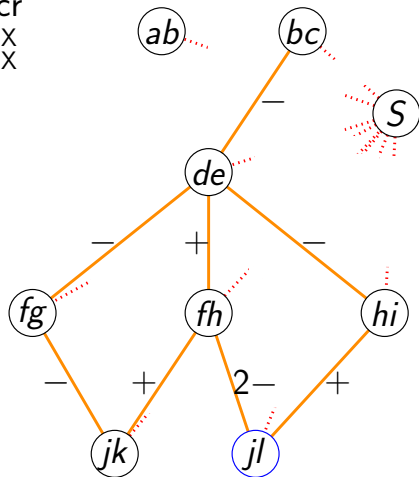

Trees on layers

Baumann, Buchheim, Liers, 2010.

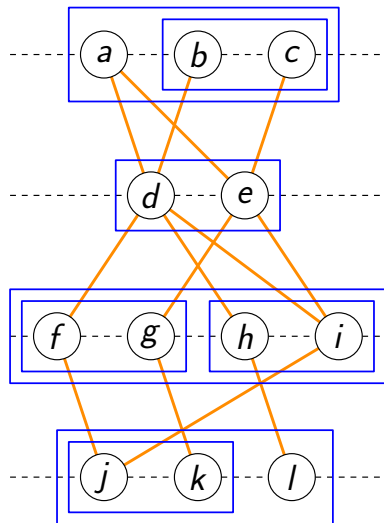

cr
x
x

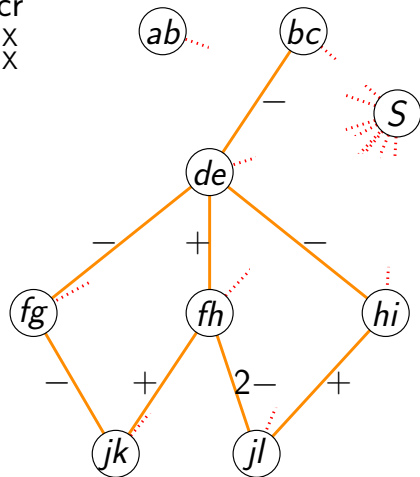

Trees on layers

Baumann, Buchheim, Liers, 2010.

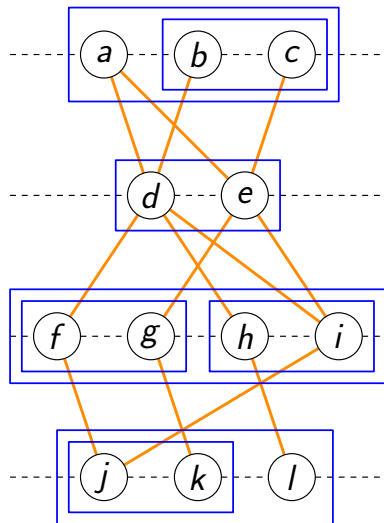

cr
x
x

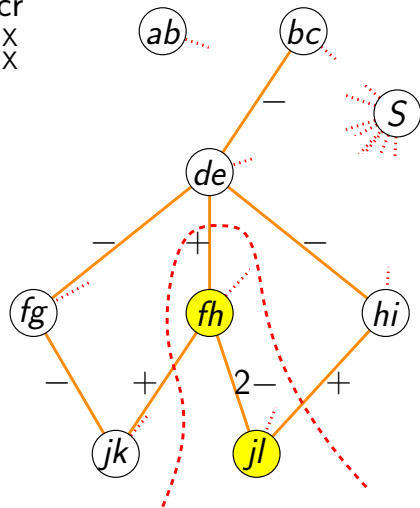

Trees on layers

Baumann, Buchheim, Liers, 2010.

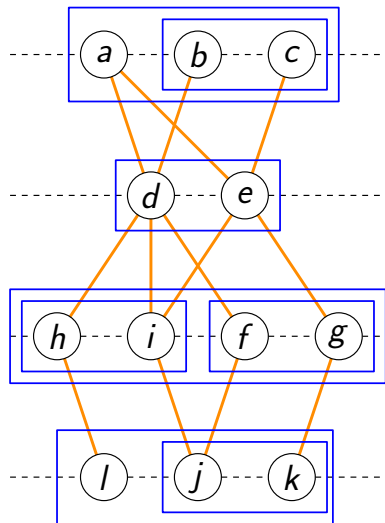

cr
x
x

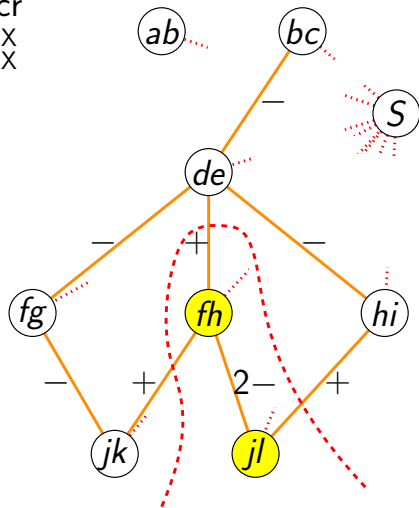

Trees on layers

Baumann, Buchheim, Liers, 2010.

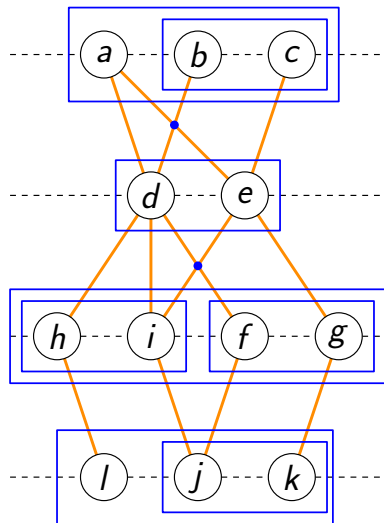

cr
x
x

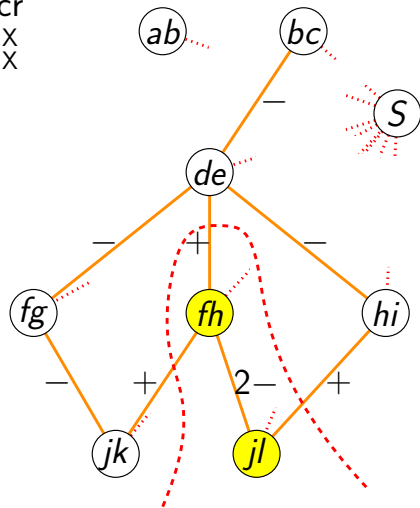

B&C computational results

	p	$ V $	$ E $	cr	Vars	Const	SubP	Time
anna1	58	409	368	20	1 944	2 744	31	13.03
anna2	58	525	489	12	3 689	2 666	1	0.88
anna3	48	265	219	0	951	0	1	0.01
anna4	49	364	334	20	2 116	2 279	13	4.86
anna5	71	615	565	17	3 821	3 242	3	2.60
anna6	56	522	495	31	3 586	4 417	3	3.89
anna7	62	467	420	9	2 525	2 360	17	7.88
anna8	28	192	175	6	1 036	851	1	0.15
huck	107	1 059	985	42	7 942	11 381	29	111.31
jean1	95	502	462	10	1 777	1 314	3	0.90
jean2	59	226	212	6	461	385	1	0.08
jean3	99	873	838	13	6 559	4 208	7	6.31
jean4	76	909	876	42	9 219	10 293	3	22.22
jean5	73	491	471	17	2 608	2 416	3	1.52
Inception	139	925	915	35	1 784	2 382	3	2.02
Star Wars	100	940	926	39	2 132	2 449	1	0.99
The Matrix	82	683	669	12	1 388	1 373	3	0.77

Book instances from Knuth: The Stanford GraphBase.

Movie instances from Tanahashi, Ma, 2012.

Storylines Visualizations - Books

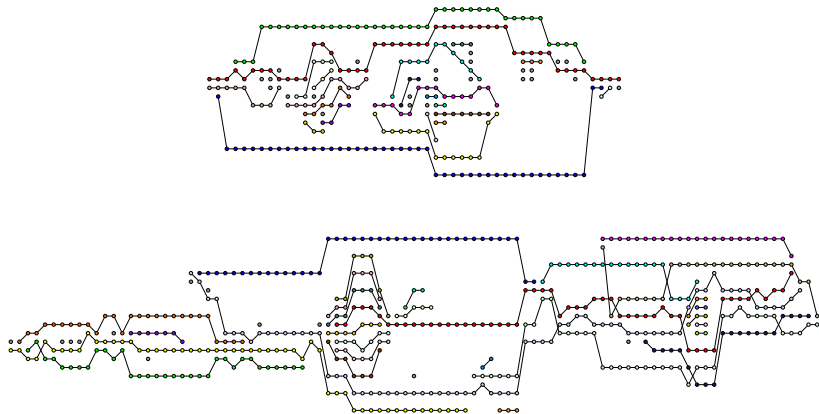

Storylines Visualizations - Movies

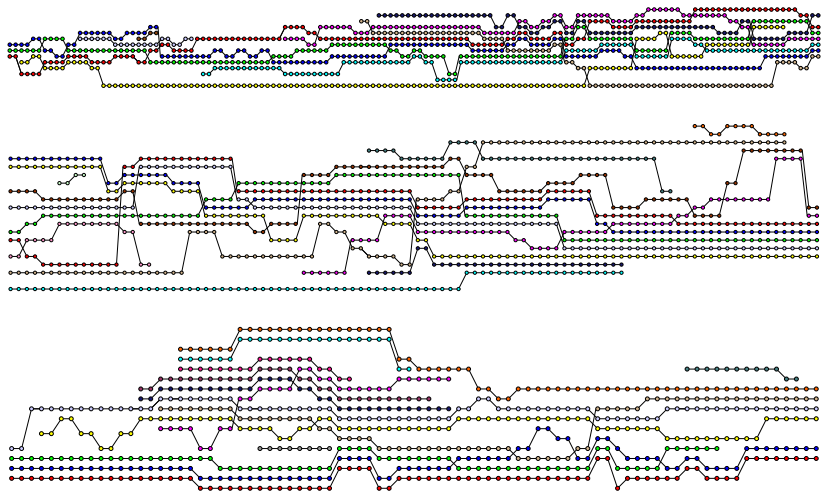

Storylines Visualizations - Chair Prof. Dr. Jünger

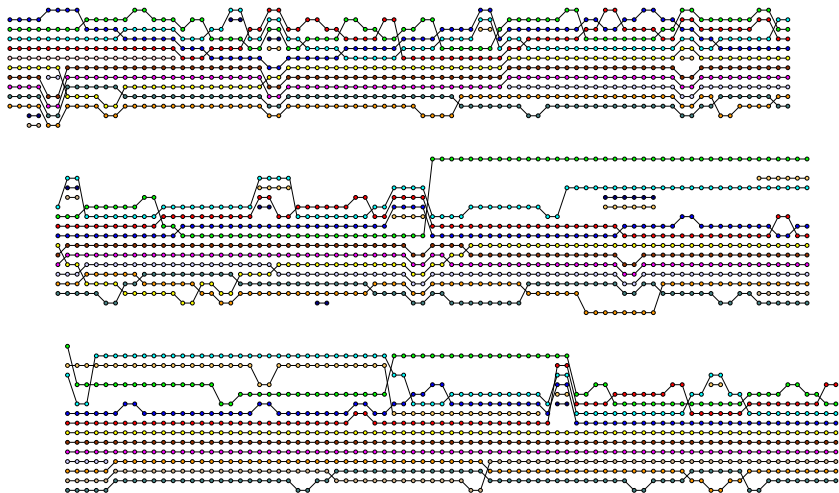

01.09.2013 - 31.08.2016

— The End —

